

# *Valcourt*

*The Fireplace of Your Dreams*

Installation and operation manual  
**MASONRY HEATER**  
**model FM0400/FM1000/FM1200/FM1500**

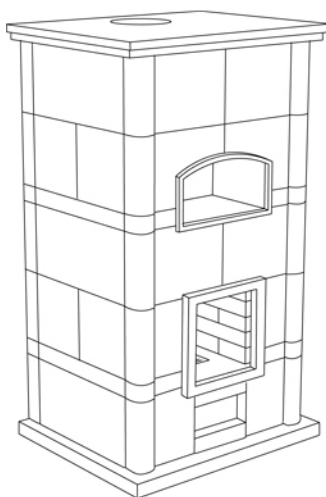

[www.valcourtinc.com](http://www.valcourtinc.com)  
Stove Builder International Inc.  
250, rue Copenhague, Saint-Augustin-de-Desmaures (Quebec) Canada G3A 2H3  
Telephone : (418) 878-3040

This manual is available for free download on the manufacturer's web site. It is a copyrighted document. Re-sale is strictly prohibited. The manufacturer may update this manual from time to time and cannot be responsible for problems, injuries, or damages arising out of the use of information contained in any manual obtained from unauthorized sources.

---

**READ AND KEEP THIS MANUAL FOR REFERENCE**

# THANK YOU FOR CHOOSING THIS APPLIANCE

Valcourt is a renowned North American manufacturer of masonry heaters who proudly stands behind the quality and performance of all its products. We hope you will get the greatest possible satisfaction from using this product.

In the pages that follow you will find general advice on wood heating, detailed instructions for safe and effective installation, and guidance on how to get the best performance from this stove as you build and maintain fires, and maintain your wood heating system.

We recommend that our wood burning hearth products be installed and serviced by professionals who are certified in the United States by NFI (National Fireplace Institute®) or in Canada by WETT (Wood Energy Technical Training) or in Quebec by APC (Association des Professionnels du Chauffage).

Congratulations for making such a wise purchasing decision. We want to thank you for the confidence you have shown in choosing one of our products. We strive to meet your requirements and needs by offering you top quality products.

When this stove is not properly installed, a house fire may result. To reduce the risk of fire, follow the installation instructions. Contact local building or fire officials about restrictions and installation inspection requirements in your area.

Please read this entire manual before you install and use your new stove. Failure to follow instructions may result in property damage, bodily injury, or even death. It is important that you follow the installations guidelines exactly.

You may need to obtain a building permit for the installation of this stove and the chimney that it is connected to. Consult your municipal building department or fire department before installation to determine the need to obtain one. We recommend that you also inform your home insurance company to find out if the installation will affect your policy. Do not install in a mobile home.

## REGISTER YOUR WARRANTY ONLINE

To receive full warranty coverage, you will need to show evidence of the date you purchased your unit. Keep your sales invoice. We also recommend that you register your warranty online at

**<http://www.valcourtinc.com/warranty-registration.aspx>**

Registering your warranty online will help us track rapidly the information we need on your unit.

## Table of Content

PART A – OPERATION AND MAINTENANCE.....	4
Safety Information .....	4
General Information .....	5
Fuel .....	6
Operating Your Heater.....	10
Maintaining Your Wood Heating System.....	12
PARTIE B - INSTALLATION .....	15
Safety Information .....	15
Foundation .....	16
Clearances to Combustible Material.....	18
The Venting System .....	22
Appendix 1 : Installation of an outside air intake .....	27
Appendix 2 : Parts list .....	28
Appendix 3 : View of all heater parts .....	29
LIMITED 5-YEARS WARRANTY .....	30

---

## **PART A - OPERATION AND MAINTENANCE**

*Please see Part B for installation instructions.*

### **Safety Information**

#### **Summary of Operation and Maintenance Cautions and Warnings**

**HOT WHILE IN OPERATION, KEEP CHILDREN, CLOTHING AND FURNITURE AWAY. CONTACT MAY CAUSE SKIN BURNS. GLOVES MAY BE NEEDED FOR STOVE OPERATION.**

**USING A STOVE WITH CRACKED OR BROKEN COMPONENTS, SUCH AS GLASS OR FIRE-BRICKS OR BAFFLES MAY PRODUCE AN UNSAFE CONDITION AND MAY DAMAGE THE STOVE.**

**OPEN THE AIR CONTROL FULLY BEFORE OPENING FIRING DOOR.**

**THIS STOVE IS NOT DESIGNED TO BE USED WITH THE DOOR OPEN. THE DOOR MAY BE OPEN ONLY DURING LIGHTING PROCEDURES OR RELOADING. DO NOT LEAVE THE STOVE UNATTENDED WHEN THE DOOR IS SLIGHTLY OPENED DURING IGNITION. ALWAYS CLOSE THE DOOR AFTER IGNITION.**

**NEVER USE GASOLINE, GASOLINE-TYPE LANTERN FUEL (NAPHTHA), FUEL OIL, MOTOR OIL, KEROSENE, CHARCOAL LIGHTER FLUID, OR SIMILAR LIQUIDS OR AEROSOLS TO START OR 'FRESHEN UP' A FIRE IN THIS STOVE. KEEP ALL SUCH LIQUIDS OR AEROSOLS WELL AWAY FROM THE STOVE WHILE IT IS IN USE.**

**DO NOT STORE FUEL WITHIN HEATER MINIMUM INSTALLATION CLEARANCES.**

**BURN ONLY SEASONED NATURAL FIREWOOD.**

**DO NOT BURN :**

**GARBAGE OF ANYKIND;**

**COAL OR CHARCOAL;**

**TREATED, PAINTED OR COATED WOOD;**

**PLYWOOD OR PARTICLE BOARD;**

**FINE PAPER, COLORED PAPER OR CARDBOARD;**

**SALT WATER DRIFTWOOD, OR**

**RAILROAD TIES.**

**DO NOT ELEVATE THE FIRE BY USING A GRATE IN THIS STOVE.**

**THIS APPLIANCE SHOULD BE MAINTAINED AND OPERATED AT ALL TIMES IN ACCORDANCE WITH THESE INSTRUCTIONS.**

## General Information

### Specifications

Fuel type	Cordwood
Test standards (safety)	ULC S627, UL 1482

### Zone Heating - How to get the most of it

Your new heater wood stove is a space heater, which means it is intended to heat the area it is installed in, as well as spaces that connect to that area, although to a lower temperature. This is called zone heating and it is an increasingly popular way to heat homes or spaces within homes.

Zone heating can be used to supplement another heating system by heating a particular space within a home, such as a basement family room or an addition that lacks another heat source.

Houses of moderate size and relatively new construction can be heated with a properly sized and located wood stove. Whole house zone heating works best when the stove is located in the part of the house where the family spends most of its time. This is normally the main living area where the kitchen, dining and living rooms are located. By locating the stove in this area, you will get the maximum benefit of the heat it produces and will achieve the highest possible heating efficiency and comfort. The space where you spend most of your time will be warmest, while bedrooms and basement (if there is one) will stay cooler. In this way, you will burn less wood than with other forms of heating.

Although the stove may be able to heat the main living areas of your house to an adequate temperature, we strongly recommend that you also have a conventional oil, gas or electric heating system to provide backup heating.

Several factors will contribute to make zone heating beneficial to you, including the right location and size of the heater, the size, layout and age of your residence, as well as your climate zone. Second homes used over three seasons annually can generally be heated with smaller stoves than homes heated throughout the winter.

### The Benefits of Low Emissions and High Performance

The low smoke emissions produced by the special features inside the heater's firebox mean that your household will release up to 90 percent less smoke into the outside environment than if you used an older conventional stove. But there is more to the emission control technologies than protecting the environment.

The smoke released from wood when it is heated contains about half of the energy content of the fuel. By burning the wood completely, your stove releases all the heat energy from the wood instead of wasting it as smoke up the chimney. Also, the features inside the firebox allow you to reduce the air supply to control heat output, while maintaining clean and efficient flaming combustion, which boosts the efficient delivery of heat to your home.

The emission control and advanced combustion features of your stove can only work properly if your fuel has an average moisture content below 18 percent. See fuel section (page 6) of this manual for suggestions on preparing fuelwood and judging its moisture.

### What is Your New Heater Made Of?

Steatite or soapstone is a natural stone quarried in the Province of Quebec in Canada. It contains the right mix of talc and magnetite to successfully store heat and withstand very high temperatures. As soapstone is inert, it is not hazardous to human health.

Vermiculite is used as firewall. It's a mineral extracted from large mines in China, Russia, South Africa and Brazil. Potassium silicate is used as a binder to form a rigid board. Vermiculite can withstand temperatures above 2000°F. It is not considered hazardous waste. It is recommended to dispose of it in a landfill.

The door and glass gaskets are fibreglass which is spun from melted sand. Black gaskets have been dipped into a solvent-free solution. Disposal at a landfill is recommended.

The door glass is a 5 mm thick ceramic material that contains no toxic chemicals. It is basically made of raw earth materials such as sand and quartz that are combined in such a way to form a glass at high temperatures. Ceramic glass will not re-melt in the same way as normal glass, so it should not be recycled with your regular household products. Disposal at a landfill is recommended.

## **Fuel**

### **Materials That Should Not be Burned**

*GARBAGE OF ANY KIND;*

*COAL OR CHARCOAL;*

*TREATED, PAINTED OR COATED WOOD;*

*PLYWOOD OR PARTICLE BOARD;*

*FINE PAPER, COLORED PAPER OR CARDBOARD;*

*SALT WATER DRIFTWOOD;*

*MANUFACTURED LOGS CONTAINING WAX OR CHEMICAL ADDITIVES;*

*RAILROAD TIES;*

*LIQUIDS SUCH AS KEROSENE OR DIESEL FUEL TO START A FIRE.*

## **How to Prepare or Buy Good Firewood**

### **What is Good Firewood?**

Good firewood has been cut to the correct length for the stove, split to a range of sizes and stacked in the open until its moisture content is reduced to 15 to 20 per cent.

### **Tree Species**

The tree species the firewood is produced from is less important than its moisture content. The main difference in firewood from various tree species is the density of the wood. Hardwoods are denser than softwoods. People who live in the coldest regions of North America usually have only spruce, birch and poplar, other low-density species to burn and yet they can heat their homes successfully.

Homeowners with access to both hardwood and softwood fuel sometimes use both types for different purposes. For example, softer woods make good fuel for relatively mild weather in spring and fall because they light quickly and produce less heat. Softwoods are not as dense as hardwoods so a given volume of wood contains less energy. Using softwoods avoids overheating the house, which can be a common problem with wood heating in moderate weather. Harder woods are best for colder winter weather when more heat and longer burn cycles are desirable.

Note that hardwood trees like oak, maple, ash and beech are slower growing and longer lived than softer woods like poplar and birch. That makes hardwood trees more valuable. The advice that only hardwoods are good to burn is outdated. Old, leaky cast iron stoves wouldn't hold a fire overnight unless they were fed large pieces of hardwood. That is no longer true. You can successfully heat your home by using the less desirable tree species and give the forest a break at the same time.

## Log Length

Logs should be cut about 1" (25 mm) shorter than the firebox so they fit in easily. Pieces that are even slightly too long make loading the stove very difficult. The most common standard length of firewood is 16" (400 mm).

The pieces should be a consistent length, with a maximum of 1" (25 mm) variation from piece to piece.

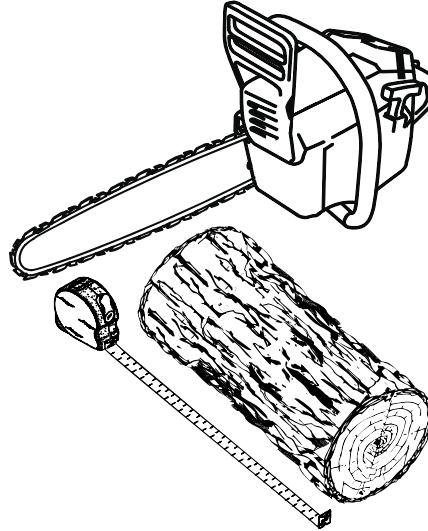

## Piece Size

Firewood dries more quickly when it is split. Large unsplit rounds can take years to dry enough to burn. Even when dried, unsplit logs are difficult to ignite because they don't have the sharp edges where the flames first catch. Logs as small as 3" (75 mm) should be split to encourage drying.

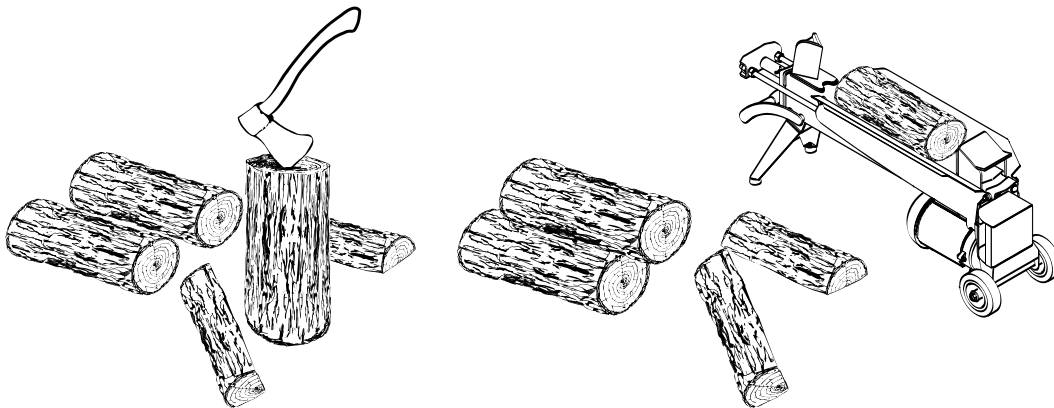

Wood should be split to a range of sizes, from about 3" to 6" (75 mm to 150 mm) in cross section. Having a range of sizes makes starting and rekindling fires much easier. Often, the firewood purchased from commercial suppliers is not split finely enough for convenient stoking. It is sometimes advisable to resplit the wood before stacking to dry.

## How to Dry Firewood

Firewood that is not dry enough to burn is the cause of most complaints about wood stoves. The complaints usually involve a lack of heat and dirty door glass.

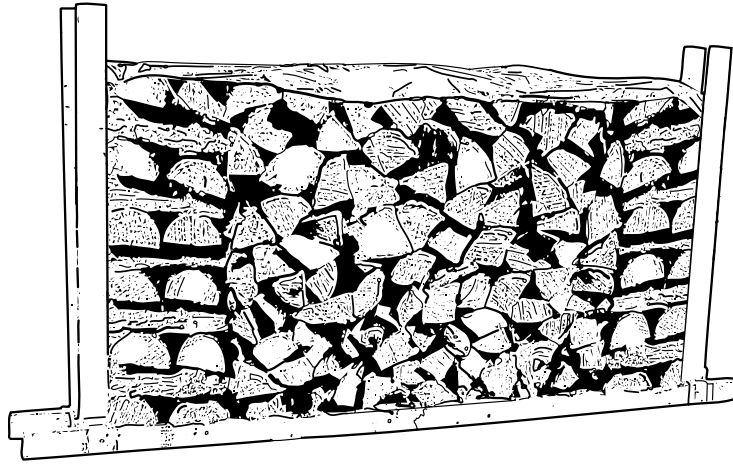

### Here are some things to consider in estimating drying time:

FIREWOOD TAKES A LONG TIME TO DRY;

FIREWOOD BOUGHT FROM A DEALER IS RARELY DRY ENOUGH TO BURN, SO IT IS ADVISABLE TO BUY THE WOOD IN SPRING AND DRY IT YOURSELF;

DRYING HAPPENS FASTER IN DRY WEATHER THAN IN DAMP, MARITIME CLIMATES;

DRYING HAPPENS FASTER IN WARM SUMMER WEATHER THAN IN WINTER WEATHER;

SMALL PIECES DRY MORE QUICKLY THAN LARGE PIECES;

SPLIT PIECES DRY MORE QUICKLY THAN UNSPLIT ROUNDS;

SOFTWOODS TAKE LESS TIME TO DRY THAN HARDWOODS;

SOFTWOODS LIKE PINE, SPRUCE, AND POPLAR/ASPEN CAN BE DRY ENOUGH TO BURN AFTER BEING STACKED IN THE OPEN FOR ONLY THE SUMMER MONTHS;

HARDWOODS LIKE OAK, MAPLE AND ASH CAN TAKE ONE, OR EVEN TWO YEARS TO DRY FULLY, ESPECIALLY IF THE PIECES ARE BIG;

FIREWOOD DRIES MORE QUICKLY WHEN STACKED IN THE OPEN WHERE IT IS EXPOSED TO SUN AND WIND; IT TAKES MUCH LONGER TO DRY WHEN STACKED IN A WOOD SHED;

FIREWOOD THAT IS READY TO BURN HAS A MOISTURE CONTENT BETWEEN 15 AND 20% BY WEIGHT AND WILL ALLOW YOUR STOVE TO PRODUCE ITS HIGHEST POSSIBLE EFFICIENCY.

## Judging Firewood Moisture Content



You can find out if some firewood is dry enough to burn by using these guidelines :

CRACKS FORM AT THE ENDS OF LOGS AS THEY DRY;

AS IT DRIES IN THE SUN, THE WOOD TURNS FROM WHITE OR CREAM COLOURED TO GREY OR YELLOW;

BANG TWO PIECES OF WOOD TOGETHER; SEASONED WOOD SOUNDS HOLLOW AND WET WOOD SOUNDS DULL;

DRY WOOD IS MUCH LIGHTER IN WEIGHT THAN WET WOOD;

SPLIT A PIECE, AND IF THE FRESH FACE FEELS WARM AND DRY IT IS DRY ENOUGH TO BURN; IF IT FEELS DAMP, IT IS TOO WET;

BURN A PIECE; WET WOOD HISSES AND SIZZLES IN THE FIRE AND DRY WOOD DOES NOT.

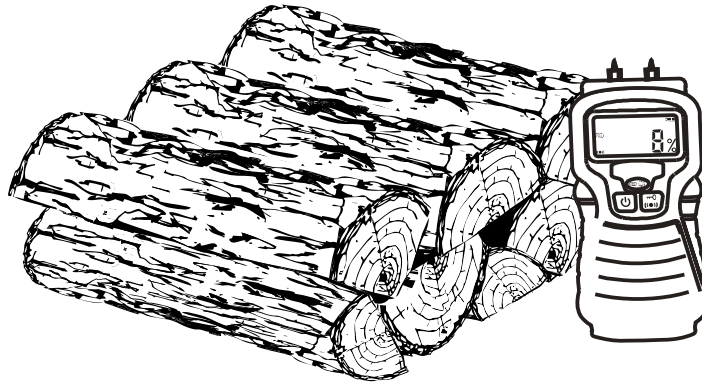

**You could buy a wood moisture meter to test your firewood.**

### **Manufactured Logs**

Do not burn manufactured logs made of wax impregnated sawdust or logs with any chemical additives. Manufactured logs made of 100% compressed sawdust can be burned, but use caution in the number of these logs burned at one time.

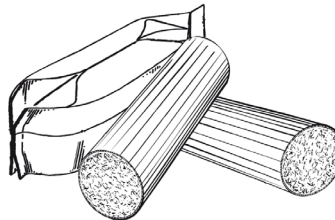

## Operating Your Heater

### Your First Fires (minimum 3 weeks after installation)

Your new heater contains a lot of moisture. So it is critical that it be thoroughly dried out before being used at full capacity. To do this, you should heat up your appliance gradually.

Check the tables below for the amount of wood and the number of fires required. Gradually increase the intensity of the fire and the wood load with each fire. This operation is very important because overly fast evaporation can damage the internal structure of your appliance. It is also important not to let the heater cool down between fires. Some water may flow out of the heater during the first fire due to internal condensation.

	Wood load requires to dry out the heater (pounds)									
Heater weight (pounds)	fire 1	fire 2	fire 3	fire 4	fire 5	fire 6	fire 7	fire 8	fire 9	fire 10
3800	10	12	14	16	18					
4500	10	13	16	19	22					
5000	10	14	18	22	25					
6000	10	15	20	25	30					
7000	10	16	22	28	35					
8000	10	13	16	19	22	25	28	30	35	40
9000	10	14	18	22	28	32	36	40	44	48

### Cold Lighting

If your heater has been out of use for a long time and is at room temperature, it is crucial that you preheat the structure with a 50% load of wood before using a full load. Structural damages can occur if the appliance is heated too quickly (thermal shocks). You must let heater temperature increase before lighting a second fire. It is preferable not to let the heater cool down between fires.

### Regular Use

Your heater is designed for fast burning, which means that the air vent should be fully open at all times. As it is designed for regular use, it must reach its cruising temperature and keep it for several weeks; repeated cold lightings will damage the heater and break up its joints. At the end of the burn cycle, when all embers have burned out, we suggest you close the chimney damper to keep the heat inside the appliance.

Heater weight (pounds)	Wood Load for a Normal Fire (pounds)		
	Normal fire maximum	Normal fire minimum	Cold lighting
3800	25	8	13
4500	25	8	13
5000	30	10	15
6000	35	12	18
7000	40	13	20
8000	45	15	23
9000	50	17	25

## Lighting a Fire

**DO NOT LEAVE THE STOVE UNATTENDED WHEN THE DOOR IS SLIGHTLY OPEN DURING IGNITION. ALWAYS CLOSE THE DOOR AFTER IGNITION.**

### Top Lighting Procedure

Your heater is designed to be lighted from the top. Pile about 75% of the wood required in criss-crossed layers. Put newspapers on top of the pile, then add the rest of the firewood. Fully open the air vents, damper and bypass before lighting up the paper.

It is critical that you wait until the fire is going well before closing the air bypass, otherwise smoke will flow into your home.

### Using Fire Starters

Many people like to use commercial fire starters instead of newspaper. Some of these starters are made of sawdust and wax and others are specialized flammable solid chemicals. Follow the package directions for use.

Gel starter may be used but only if there are no hot embers present. Use only in a cold firebox to start a fire.

**DO NOT USE FLAMMABLE LIQUIDS SUCH AS GASOLINE, NAPHTHA, FUEL OIL, MOTOR OIL, OR AEROSOLS TO START OR REKINDLE THE FIRE.**

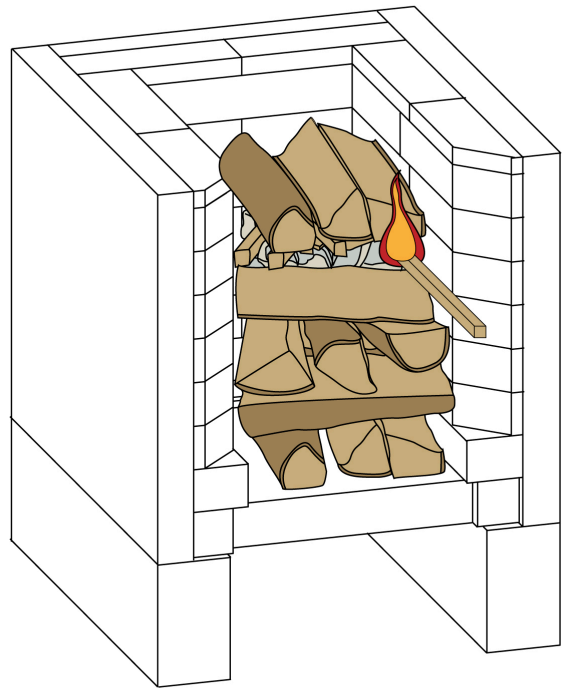

## Maintaining Wood Fires

### General Advice

**IF YOU MUST OPEN THE DOOR WHILE THE FUEL IS FLAMING, OPEN THE AIR CONTROL FULLY FOR A FEW MINUTES, THEN UNLATCH AND OPEN THE DOOR SLOWLY.**

### Ash Removal

Ash should be removed from the firebox every two or three days of full time heating. Do not let the ash build up in the firebox because it will interfere with proper fire management.

The best time to remove ash is after an overnight fire when the stove is relatively cool, but there is still some chimney draft to draw the ash dust into the stove and prevent it from coming into the room.

After ashes have been removed from the stove and placed in a tightly covered metal container, they should be taken outside immediately. The closed container of ashes should be placed on a non-combustible floor or on the ground well away from all combustible materials pending final disposal. Ashes normally contain some live charcoal that can stay hot for several days. If the ashes are disposed of by burial in soil or otherwise locally dispersed, they should be retained in the closed container until all cinders have thoroughly cooled. Other waste shall not be placed in this container.

**NEVER STORE ASHES INDOORS OR IN A NON-METALIC CONTAINER OR ON A WOODEN DECK.**

### Moving Embers

When the wood is practically all burned, the remaining embers must be moved to the center of the firebox, where the air intake is located. This helps the embers burn out faster so the fire can die out.

Steatite (soapstone) is designed to absorb heat fast and then radiate it slowly. This is why a good fire should get going relatively quickly to store up heat in the appliance as the energy contained in the firewood is at its peak.

### Air Intake Control

The heater has an air intake control. This device is used to control the flow of air into the heater. The fire needs the right amount of air to be going at full capacity. If the air inflow is too great, the fire loses efficiency. If the fire does not have enough air, it will tend to smolder and the wood will burn less efficiently. The heater will thus have a poorer performance.

#### Open air control

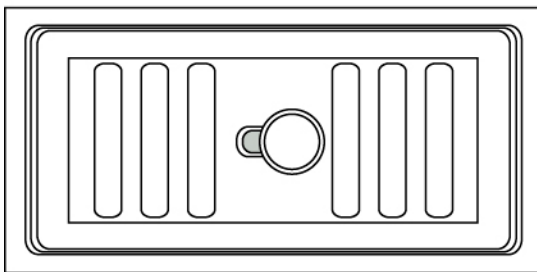

#### Closed air control

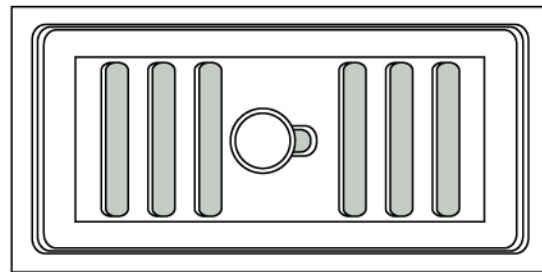

## Maintenance of your Wood-Heating System

### Heater Maintenance

Your new stove will give many years of reliable service if you use and maintain it correctly. Some of the internal components of the firebox, comme les briques de stéatite pourront avoir de légères fissures pouvant survenir mais n'affectent en rien le bon fonctionnement de l'appareil. Si vous allumez chaque charge à chaud au début d'un cycle comme décrit ci-dessus, cela ne causera pas de détérioration prématurée du foyer.

### Cleaning Door Glass

Under normal conditions, glass doors should remain relatively clean. If your firewood is dry and you follow the directions in this document, a dusty whitish deposit will appear on the inner surface of the glass after using the appliance for about a week. This is normal, and the deposit can be easily removed when the heater is cold by wiping the glass with a damp cloth or paper towel, and letting it dry. Never clean the glass when the stove is hot.

If you do get brown stains on the glass you can remove them with special cleaners for wood stove glass doors. Do not use abrasives to clean your stove's door glass.

The deposits that form on the glass are the best indication of the quality of your fuel and how well you are doing in operating the stove. Your goal should be clear glass with no brown stains. If you continue to see brown stains on the glass, something about your fuel and operating procedure needs to be changed. Stains on the glass indicate incomplete combustion of the wood, which also means more smoke emissions and faster formation of creosote in the chimney.

If you see brown streaks coming from the edge of the glass, it is time to replace the gasket around the glass. Visit your stove retailer to get the self-adhesive glass gasket and follow the instructions below for installation.

### Replacing the Door Gasket

After a year or more of use, the door gasket will compress and become hard, which may allow air to leak past it. You can test the condition of the door gasket by closing and latching the door on a strip of paper. Test all around the door. If the paper slips out easily anywhere, it is time to replace the gasket.

Use the correct replacement gasket that you can purchase from your retailer. The diameter and density of the gasket is important to getting a good seal.

Place the door face-down on something soft like a cushion of rags or piece of carpet. Remove the old gasket from the door by pulling and prying it out with an old screw driver. Then use the screwdriver to scrape the old gasket adhesive from the door. Now run a 1/4" (6 mm) bead of high temperature silicone in the door gasket groove. Starting from the middle of the hinge side, press the gasket into the groove. Do not stretch the gasket as you place it. Leave the gasket about 1/2" long when you cut it and press the end into the groove. Tuck any loose fibres under the gasket and into the silicone. Close the door and do not use the stove for 24 hours.

### Replacing the Glass Gasket and/or the Glass

It is a good idea to replace the glass gasket when the door gasket is replaced. The gasket is flat, adhesive-backed, woven fibreglass. Remove the glass retaining screws and clips. Lift out the glass and pull off the old gasket. This is a good time to clean the glass thoroughly.

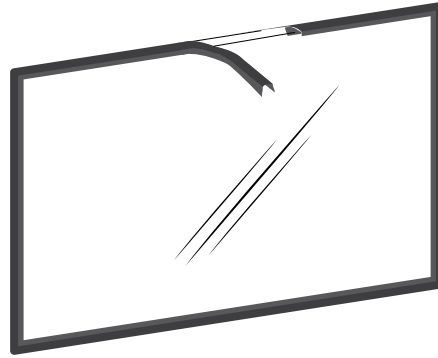

The gasket must be centred on the edge of the glass. To do this easily, peel back a section of the paper covering the adhesive and place the gasket on a table with the adhesive side up. Stick the end of the gasket to the middle of one edge, then press the edge of the glass down onto the gasket, taking care that it is perfectly centred on the gasket. Peel off more of the backing and rotate the glass and press the next section onto the gasket. Do not stretch the gasket as you place it. Continue until you get to the start and trim the gasket to length. Now pinch the gasket to the glass in a U shape, all around the glass. Reinstall the glass, being careful to centre the glass carefully in the door. Do not over-tighten the screws. Note that the two main causes of broken door glass are uneven placement in the door and over-tightening of retaining screws.

Do not abuse the glass door by striking or slamming shut. Do not use the stove if the glass is broken. To change the glass, perform the same operation described above.

## **Maintenance of the Chimney and Chimney Connector**

### **Why Chimney Cleaning is Necessary**

Wood smoke can condense inside the chimney connector and chimney, forming a combustible deposit called creosote. If creosote is allowed to build up in the venting system it can ignite when a hot fire is burned in the stove and a very hot fire can progress to the top of the chimney. Severe chimney fires can damage even the best chimneys. Smouldering, smoky fires can quickly cause a thick layer of creosote to form. When you avoid smouldering so the exhaust from the chimney is mostly clear, creosote builds up more slowly. Your new stove has the right characteristics to help you to burn clean fires with little or no smoke, resulting in less creosote in the chimney.

### **How Often Should You Clean the Chimney?**

It is not possible to predict how much or how quickly creosote will form in your chimney. It is important, therefore, to check the build-up in your chimney monthly when getting used to the new stove until you determine the rate of creosote formation. Even if creosote forms slowly in your system, the chimney should be cleaned and inspected at least once each year.

Contact your local municipal or provincial fire authority for information on how to handle a chimney fire. Have a clearly understood plan to handle a chimney fire.

### **Cleaning the Chimney**

Chimney cleaning can be a difficult and dangerous job. If you don't have experience cleaning chimneys, you might want to hire a professional chimney sweep to clean and inspect the system for the first time. After having seen the cleaning process, you can decide if it is a job you would like to take on.

The most common equipment used are fibreglass rods with threaded fittings and stiff plastic brushes. The brush is forced up and down inside the chimney flue to scrub off the creosote.

The chimney connector assembly should always be cleaned at the same time the chimney is cleaned.

## **PART B - INSTALLATION**

### **Safety Information**

#### **Summary of Installation Cautions and Warnings**

**THE INFORMATION GIVEN ON THE CERTIFICATION LABEL AFFIXED TO THE APPLIANCE ALWAYS OVERRIDES THE INFORMATION PUBLISHED, IN ANY OTHER MEDIA (OWNER'S MANUAL, CATALOGUES, FLYERS, MAGAZINES AND/OR WEB SITES).**

**MIXING OF APPLIANCE COMPONENTS FROM DIFFERENT SOURCES OR MODIFYING COMPONENTS MAY RESULT IN HAZARDOUS CONDITIONS. WHERE ANY SUCH CHANGES ARE PLANNED, STOVE BUILDER INTERNATIONAL INC. SHOULD BE CONTACTED IN ADVANCE.**

**ANY MODIFICATION OF THE APPLIANCE THAT HAS NOT BEEN APPROVED IN WRITING BY THE TESTING AUTHORITY VIOLATES CSA B365 (CANADA), AND ANSI NFPA 211 (USA).**

**CONNECT THIS STOVE ONLY TO A LISTED FACTORY-BUILT CHIMNEY FOR USE WITH SOLID FUEL OR TO A LINED MASONRY CHIMNEY CONFORMING TO NATIONAL AND LOCAL BUILDING CODES.**

**IF REQUIRED, A SUPPLY OF COMBUSTION AIR SHALL BE PROVIDED TO THE ROOM OR SPACE.**

**DO NOT CONNECT TO OR USE IN CONJUNCTION WITH ANY AIR DISTRIBUTION DUCTWORK UNLESS SPECIFICALLY APPROVED FOR SUCH INSTALLATION.**

**DO NOT CONNECT THIS UNIT TO A CHIMNEY FLUE SERVING ANOTHER APPLIANCE.**

#### **Regulations Covering Stove Installation**

In Canada, the CSA B365 Installation Code for Solid Fuel Burning Appliances and Equipment and the CSA C22.1 Canadian National Electrical Code are to be followed in the absence of local code requirements. In the USA, the ANSI NFPA 211 Standard for Chimneys, Fireplaces, Vents and Solid Fuel-Burning Appliances and the ANSI NFPA 70 National Electrical Code are to be followed in the absence of local code requirements.

This heater must be connected to a chimney complying with the requirements for Type HT chimneys in the Standard for Factory-Built Chimneys for Residential Type and Building Heating Appliances, UL 103 and ULC S629 or to a code-approved masonry chimney with a flue liner.

### Foundation with insulation

Any foundation must be flat and level.

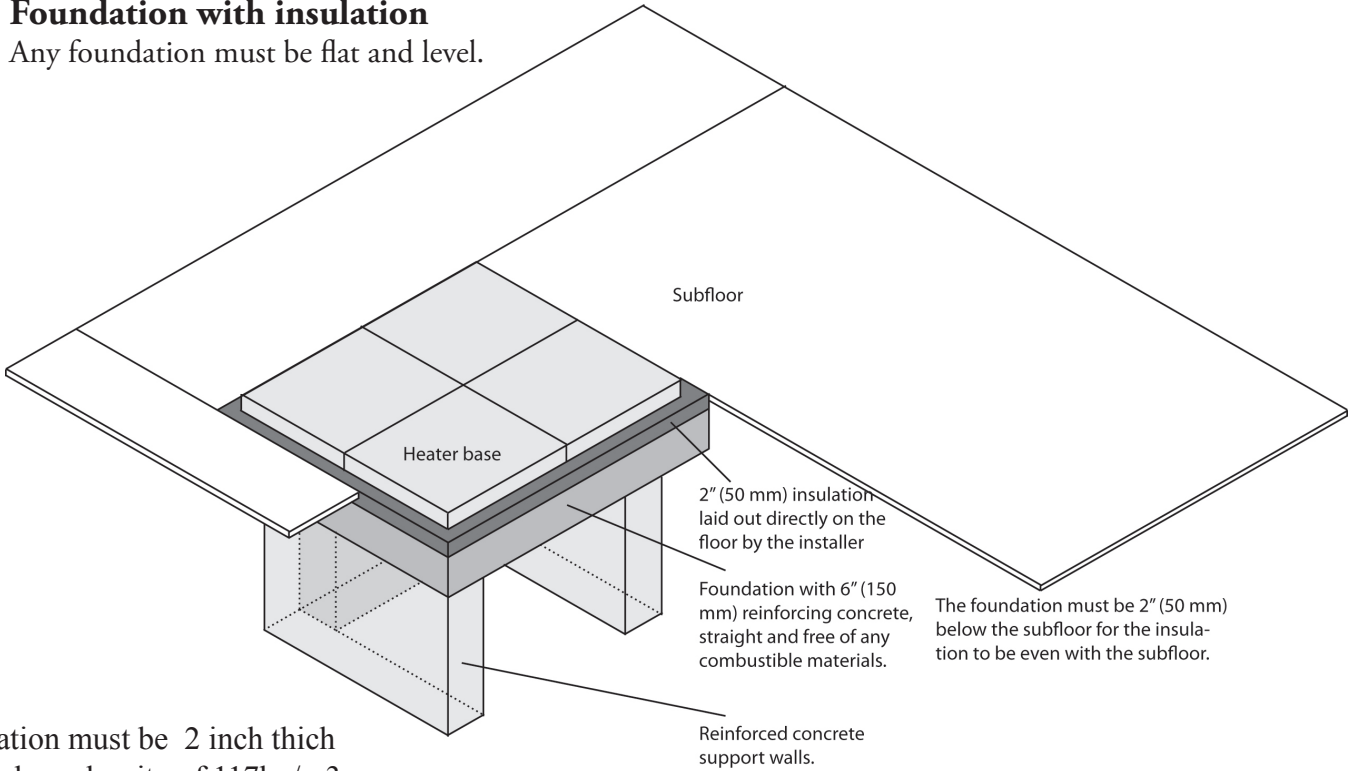

Insulation must be 2 inch thick foamglass density of 117kg/m<sup>3</sup> or 7.3 lbs/ft<sup>3</sup> with a compressive strength of 620 kpa or 90 pounds/inch<sup>2</sup>.

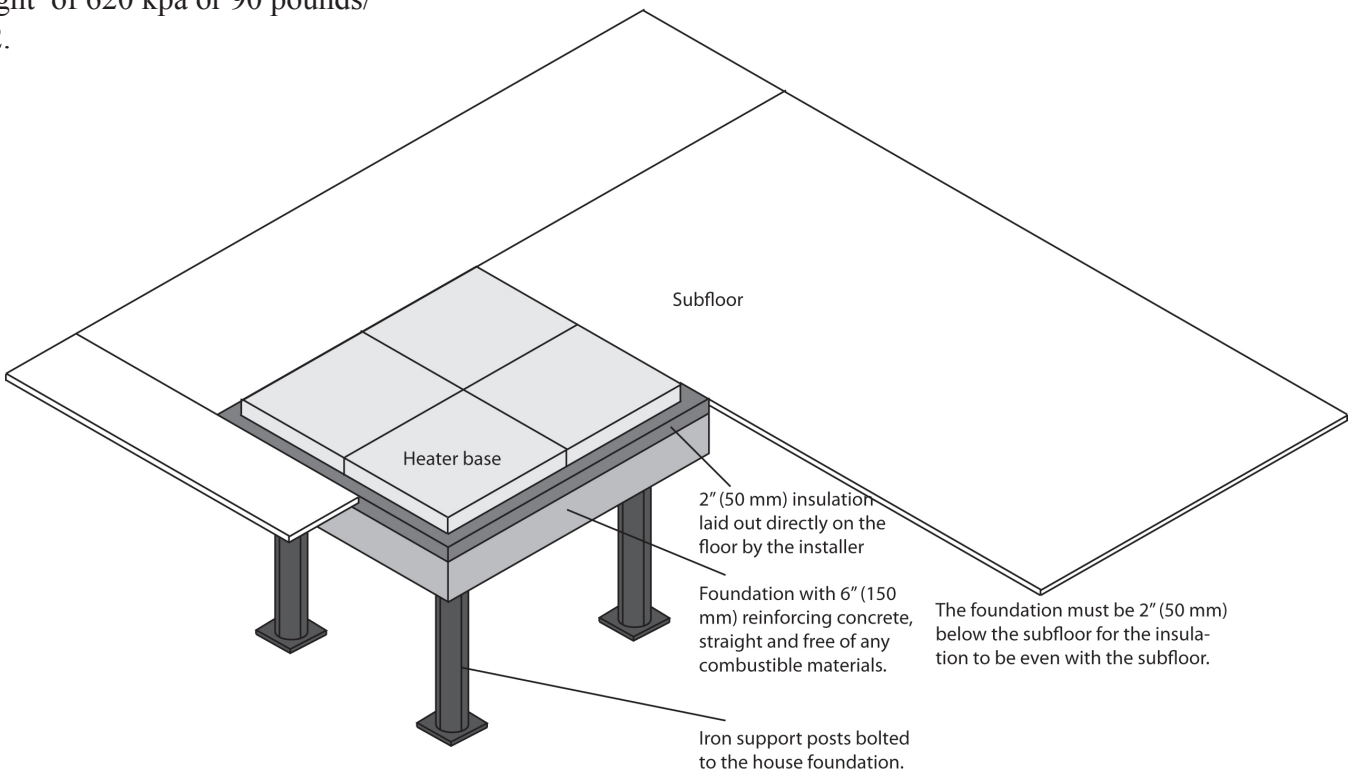



### Foundation without insulation

Any foundation must be flat and level. The foundation must be even with the subfloor.

-Concrete on a wood structure does not qualify as a concrete floor.

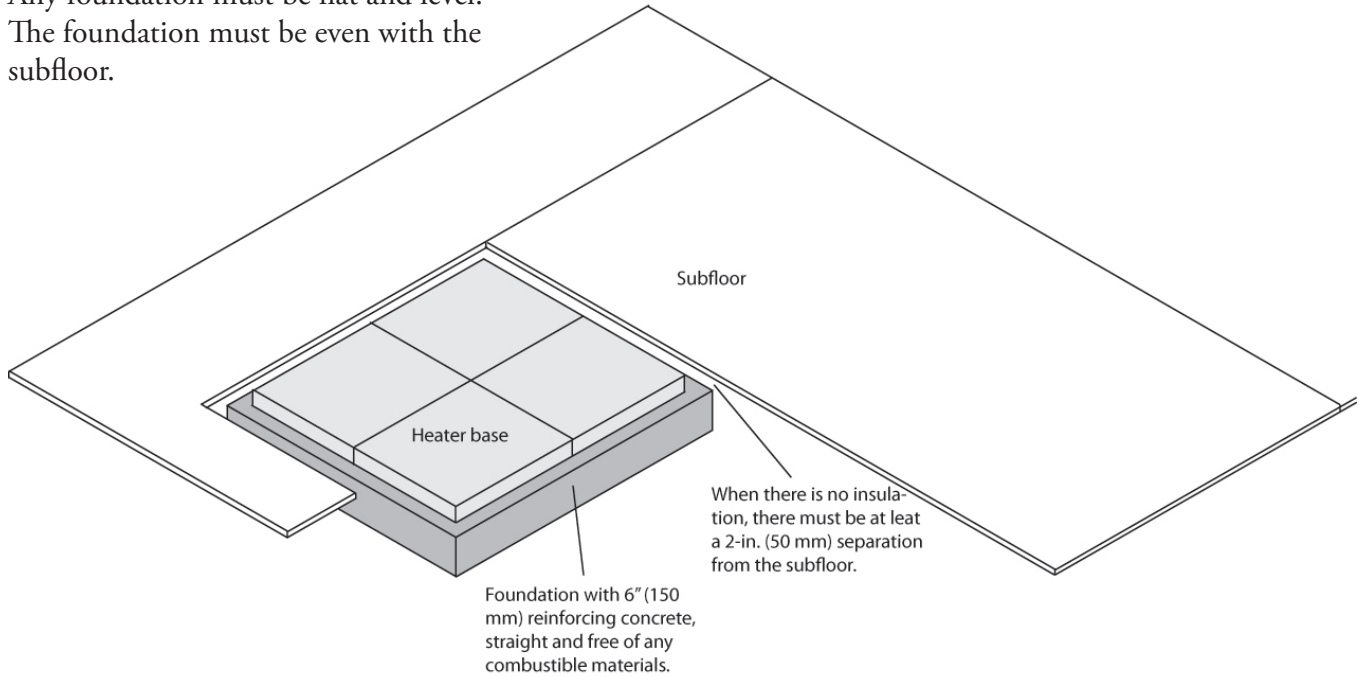

### Foundation directly on the floor

A small heater may be installed directly on the floor with a 2-in. insulation and reinforcements under the floor.

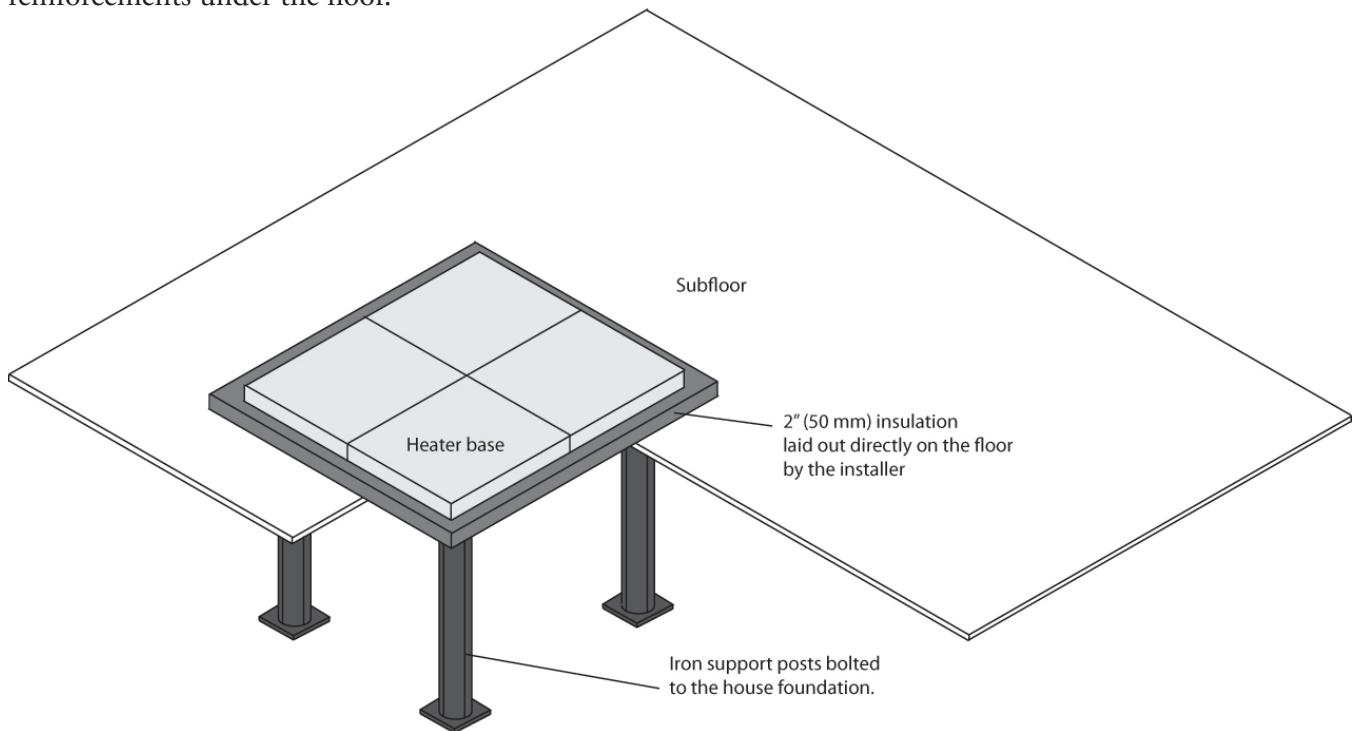

### **Clearances to combustible material**

- 1) MINIMUM CLEARANCE MUST BE 14" (350 MM) ON THE SIDES OF A FLUE WITH A 3.5" (90 MM) THICK OUTER SHELL.
- 2) MINIMUM CLEARANCE MUST BE 20" (500 MM) ON THE SIDES OF A FLUE WITH ONLY A 2.375" (60 MM) THICK OUTER SHELL.
- 3) MINIMUM CLEARANCE ABOVE THE HEATER MUST BE 10" (250 MM).
- 4) THE HEATER MUST BE ASSEMBLED ON A 2" (50 MM) THICK NON-COMBUSTIBLE SURFACE OR FOAMGLASS TYPE INSULATING MATERIAL.
- 5) WHEN A NON-HEATING SHELF OR BENCH 3" (75 MM) THICK OR LESS IS ATTACHED TO THE HEATER, IT CAN BE OVERLOOKED FOR PURPOSES OF CLEARANCES.
- 6) CLEARANCES FOR KITCHENETTES ARE 20" (500 MM) IN ALL DIRECTIONS.
- 7) 7) WHEN THE HEATER IS IN A CUBICLE, SIDE CLEARANCES INCREASE FROM 14" (350 MM) TO 20" (500 MM).

The clearances shown in this section have been determined by test according to procedures set out in safety standards ULC S627 (Canada), UL1482 (U.S.A.) . When the stove is installed so that its surfaces are at or beyond the minimum clearances specified, combustible surfaces will not overheat under normal and even abnormal operating conditions.

No part of the stove or flue pipe may be located closer to combustibles than the minimum clearance figures given.

### **Location of the Certification Label**

Since the information given on the certification label affixed to the appliance always overrides the information published, in any other media (owner's manual, catalogues, flyers, magazines and/or web sites) it is important to refer to it in order to have a safe and compliant installation. In addition, you will find information about your stove (model, serial number, etc.). You can find the certification label on the back of the stove.

### **Clearances to Walls and Ceiling**

The clearances to combustible walls may be slightly different in Canada and the U.S.A. and may also differ depending on whether you use single or double wall flue pipe. Please be sure to choose the correct clearance for your location and type of flue pipe. See figure Clearances to combustible materials and floor protection to match each letter to a clearance.

### Clearances to combustible materials and floor protection

	Clearances to walls		Clearances to walls (Heat shield)	
	CANADA	USA	CANADA	USA
A	18" (450 mm)	18" (450 mm)		
B	18" (450 mm)	18" (450 mm)	18" (450 mm)	18" (450 mm)
C	48" (1200 mm)	48" (1200 mm)	48" (1200 mm)	48" (1200 mm)
G	May vary depending on the type of chimney See Building Code			
H				
I			4" (100 mm)	4" (100 mm)
J	6" (150 mm)	6" (150 mm)	6" (150 mm)	6" (150 mm)

### Clearances to combustible materials and floor protection

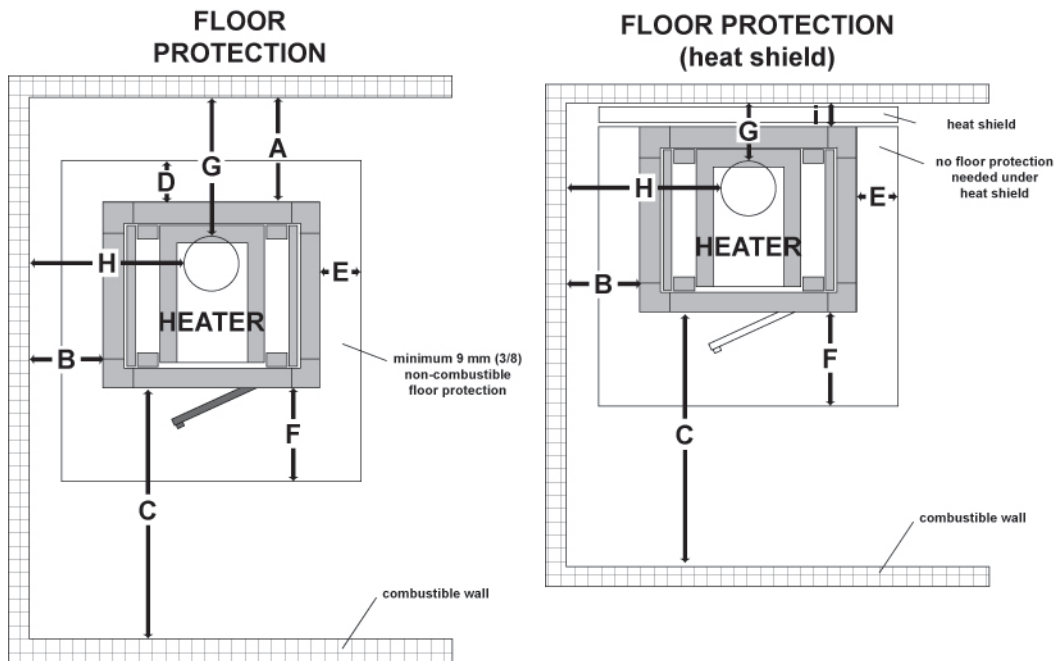

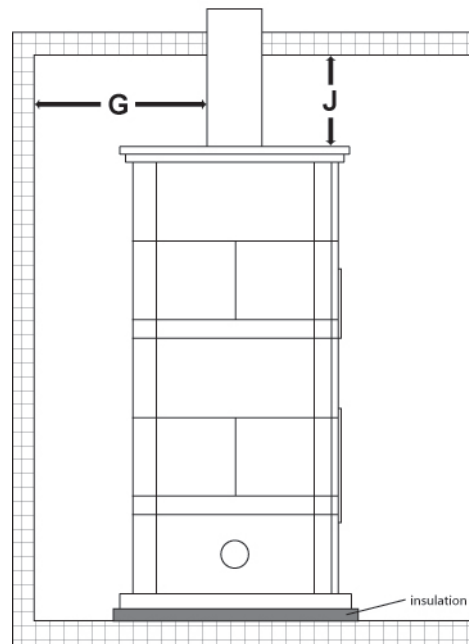

## Floor Protector

Your stove is designed to keep the floor from overheating. It must, however, be placed on a non-flammable surface to protect the floor from hot ashes that may fall from the stove during loading and maintenance. There are differences regarding floor protection between Canada and the U.S., as shown in the table below and the figure Clearances to combustible materials and floor protection.

	Floor protection	
	CANADA	USA
D**	200	200
E**	200	200
F**	450	400

\*Steel with a minimum thickness of 0.015" (0.38 mm) or ceramic tiles with grout joints. No protection is required if the appliance is installed on a non-combustible surface (eg.: concrete floor).

\*\* See: Clearances to combustible materials and floor protection

**Note 1:** Floor protection is limited to back clearances (A) if it is less than 8 inches (203 mm).

**Note 2:** Only required under the connector's horizontal (Ho) section. Should exceed by at least 2 inches (51 mm) on either side of the connector.

## Safely Reducing Clearances to Walls and Ceilings

It is often desirable to reduce installation clearances by placing the heater closer to the wall in order to take up less floor space. It is possible to safely reduce clearances by permanently installing a protective shield between the stove and flammable materials. Rules governing protective shields are sometimes complicated; read and follow them carefully. Note that there may be slight regional differences in the rules for reducing clearances; check with your building or fire protection inspector before starting any work.

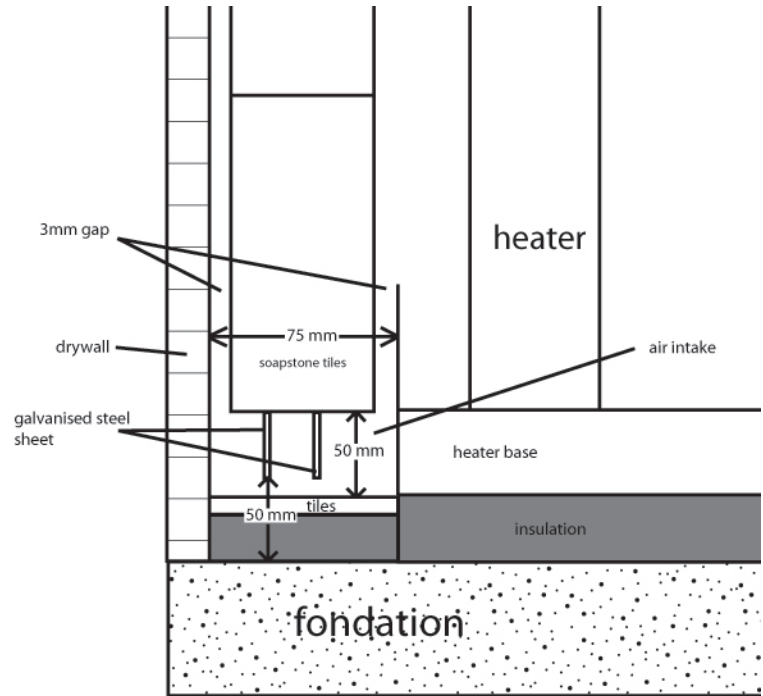

### Heat Shield\*

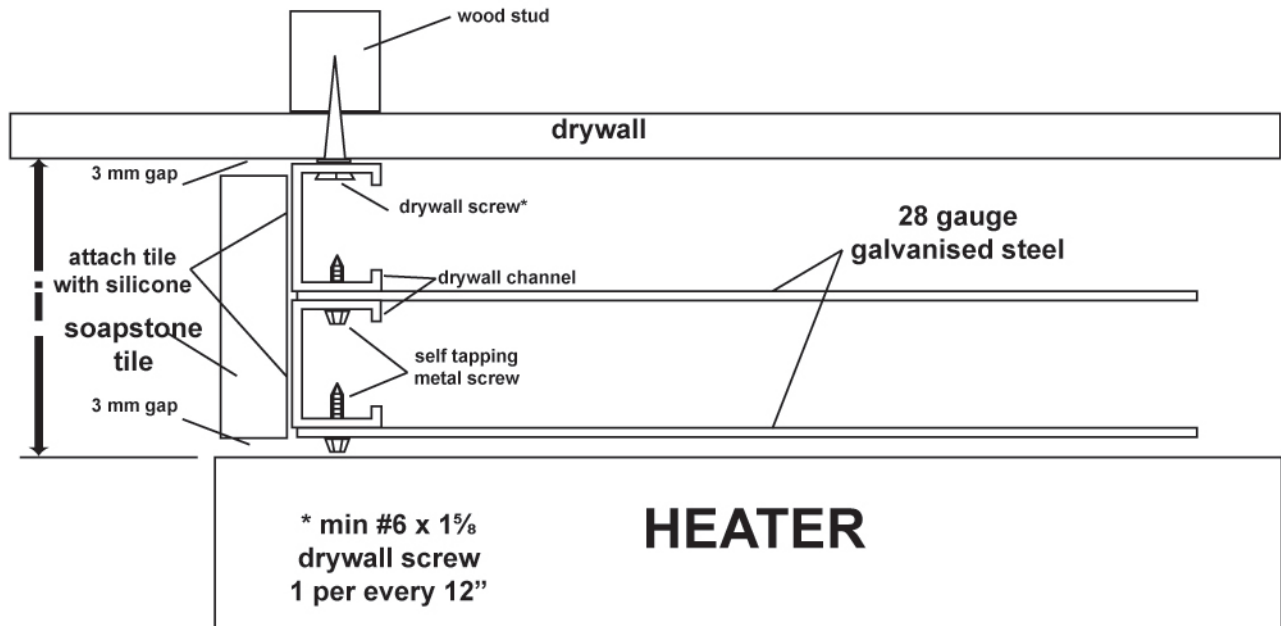

\*Consistent with approval (tested) if the heat shield is used in this way.

## The Venting System

### General

The venting system, made up of the chimney and the connecting pipe between the stove and the chimney, acts as the engine that drives your wood heating system. Even the best stove will not function safely and efficiently as intended if it is not connected to a suitable chimney.

The heat in the flue gases that pass from the stove and chimney connector into the chimney is not waste heat. This heat is what the chimney uses to make the draft that draws in combustion air, keeps smoke inside the stove and safely vents exhaust to outside. You can think of heat in the flue gas as the fuel the chimney uses to make draft.

### Suitable Chimneys

Your wood stove will provide optimum efficiency and performance when connected to a 6-inch diameter chimney flue system. The connection to a chimney having a diameter of at least 5 inches (Canada only) or no more than 7 inches is permitted, if it allows the proper venting of combustion gases and that such application is verified and authorized by a qualified installer. Otherwise, the flue diameter will have to be the one specific to the heater.

To be suitable, a factory-built metal chimney must comply with UL 103 (U.S.A.) or ULC S629 (Canada).

### Factory-built Metal Chimneys

These are sometimes referred to as 'high temp' chimneys because they have the special characteristics to withstand the temperatures that can be created by wood burning stoves. Factory-built chimneys are tested as a system with all the necessary components for installation. The instructions provided with the chimney by its manufacturer are the only reliable source of installation guidelines. To be safe and effective, the chimney must be installed exactly in accordance with the manufacturer's instructions. Use only components intended for the brand and model of chimney you are using. Never substitute parts from other chimney brands or fabricate your own components. The chimney must be a type suitable for solid fuel.

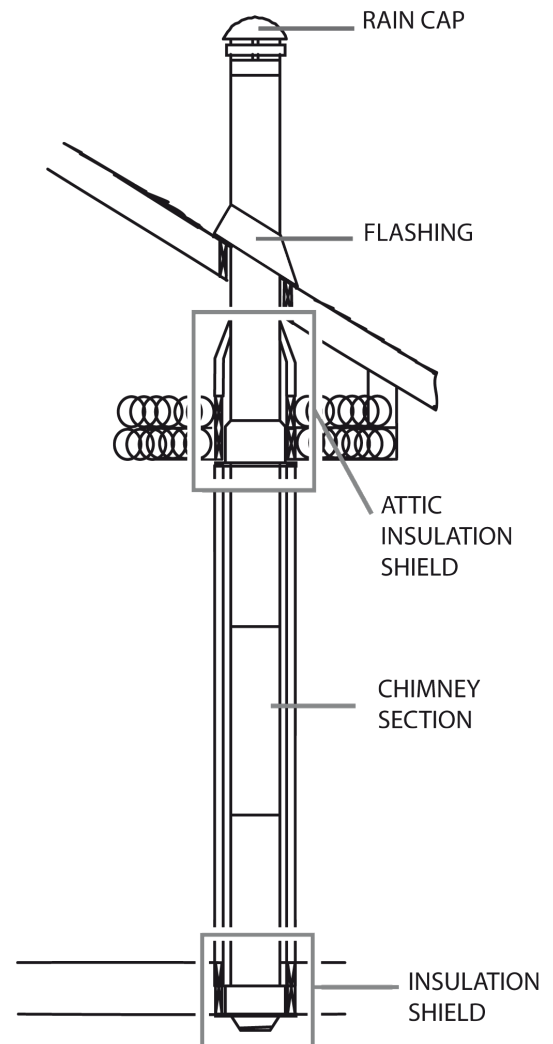

### Masonry Chimneys

The stove may also be connected to a masonry chimney, provided the chimney complies with the construction rules found in the building code enforced locally. The chimney must have either a clay liner or a suitably listed stainless steel liner. If the masonry chimney has a square or rectangular liner that is larger in cross sectional area than a round 6" flue, it should be relined with a suitably listed 6" stainless steel liner. Do not downsize the flue to less than 6" unless the venting system is straight and exceeds 25 feet in height. When passing through a combustible wall, the use of a factory built thimble is required.

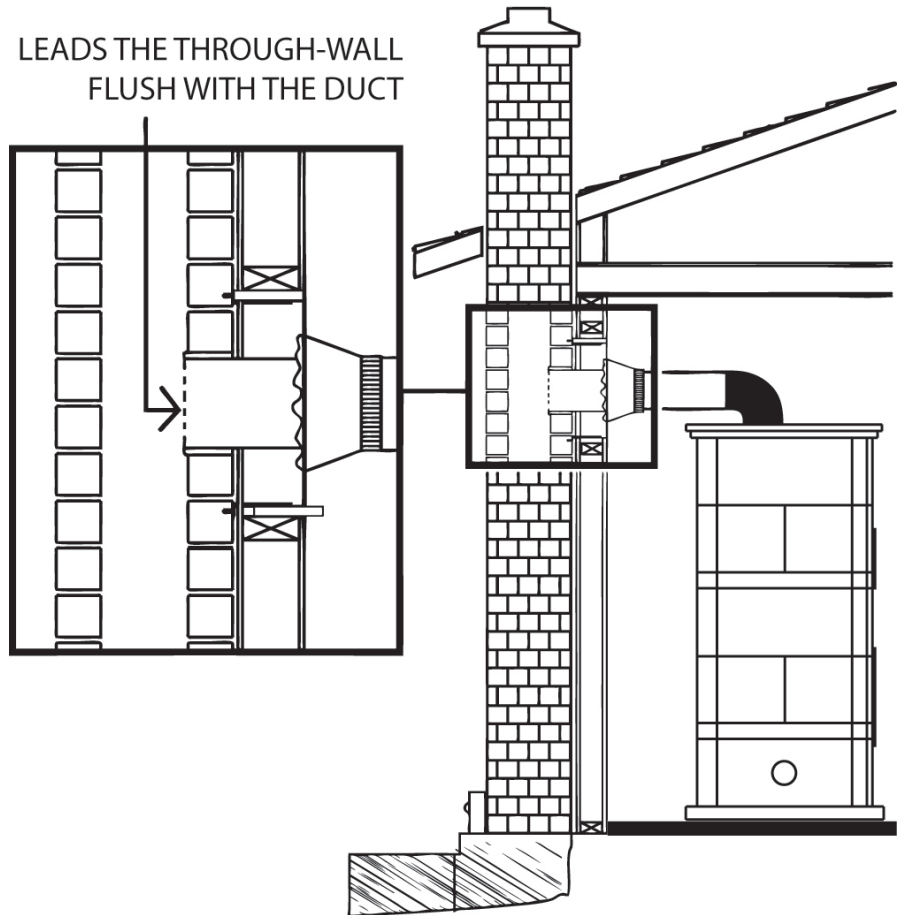

### Minimum Chimney Height

The top of the chimney should be tall enough to be above the air turbulence caused when wind blows against the house and its roof. The chimney must extend at least 1 m (3 ft.) above the highest point of contact with the roof, and at least 60 cm (2 ft.) higher than any roof line or obstacle within a horizontal distance of 3 m (10 ft.).

## The Relationship Between the Chimney and the House

Because the venting system is the engine that drives the wood heating system, it must have the right characteristics. The signs of bad system design are cold backdrafting when there is no fire in the stove, slow kindling of new fires, and smoke roll-out when the door is opened for loading. There are two guidelines to follow. First, the chimney should be installed up through the heated space of the house, not out and up an outside wall. Second, the chimney should penetrate the top of the building at or near the highest heated space.

### Why inside chimneys are preferred

Venting systems that rise straight up from the stove flue collar provide the best performance. Chimneys that rise inside the warm space of the house tend to provide a small amount of draft even when there is no fire burning. This means that when you light a fire, the initial smoke goes up the chimney and strong draft builds quickly as the chimney flue warms up. Although they are common in North America, chimneys that exit a house wall and run up outside can cause problems.

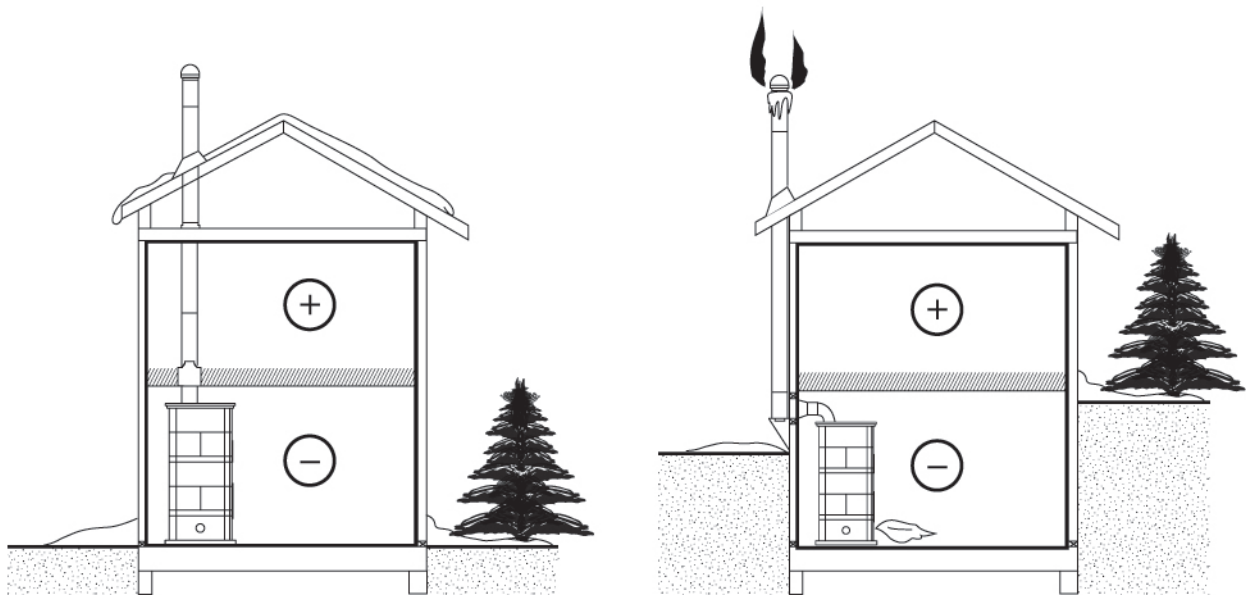

#### Good System design

Inside chimneys are preferred because even when no fire is burning, there is normally upward flow in the system.

#### Inferior System Design

Outside chimneys are a problem because when no fire burns they will go into cold backdraft if the stove is installed low in the house.

### Why the chimney should penetrate the highest heated space

When it is cold outside, the warm air in the house is buoyant so it tends to rise. This tendency of warm air to rise creates a slight pressure difference in the house. Called 'stack effect', it produces a slightly negative pressure low in the house (relative to outside) and a slightly positive pressure zone high in the house. If there is no fire burning in a heater connected to a chimney that is shorter than the warm space inside the house, the slight negative pressure low in the house will compete against the desired upward flow in the chimney.



There are two reasons why the chimney in the house at right will cold backdraft when it is cold outside and there is no fire burning in the stove. First, the chimney runs up the outside of the house, so the air in it is colder and denser than the warm air in the house. And second, the chimney is shorter than the heated space of the house, meaning the negative pressure low in the house will pull outside air down the chimney, through the stove and into the room. Even the finest stove will not work well when connected to this chimney.

### **Supply of Combustion Air**

In Canada, wood stoves are not required to have a supply of combustion air from outdoors (except in mobile homes) because research has shown that these supplies do not give protection against house depressurization and may fail to supply combustion air during windy weather. However, to protect against the risk of smoke spillage due to house depressurization, a carbon monoxide (CO) detector/alarm is required in the room in which the stove is installed. The CO detector will provide warning if for any reason the wood stove fails to function correctly.

### **Air Supply in Conventional Houses**

The safest and most reliable supply of combustion air for your wood stove is from the room in which it is installed. Room air is already preheated so it will not chill the fire, and its availability is not affected by wind pressures on the house. Contrary to commonly expressed concerns, almost all tightly-sealed new houses have enough natural leakage to provide the small amount of air needed by the stove. The only case in which the wood stove may not have adequate access to combustion air is if the operation of a powerful exhaust device (such as a kitchen range exhaust) causes the pressure in the house to become negative relative to outdoors.

Some jurisdictions in the United States require that wood stoves have a supply of combustion air from outdoors. If you do install an air supply through the wall of the house, be aware that its pressure can be affected during windy weather. If you notice changes in wood stove performance in windy weather, and in particular if smoke puffs from the stove, you should disconnect the outdoor air duct from the stove and remove the duct. In some windy conditions, negative pressure at the duct weatherhood outside the house wall may draw hot exhaust gases from the stove backwards through the duct to outdoors. Check the outdoor air duct for soot deposits when the full system is cleaned and inspected at least once each year.

### **Installing the Chimney Connector**

The chimney connector is the single or double wall pipe installed between the stove flue collar and the chimney breech. Single wall pipe components are available from most hardware and building supply stores. These components are not usually tested to a particular standard and certified as compliant. Therefore, a list of rules found in solid fuel installation codes apply to the installation of single wall pipe.

Double wall chimney connectors are tested and certified. The rules for double wall pipe are found in the manufacturer's installation instructions. These rules will be very different than those for single wall.

### **Installation of Single Wall Chimney Connector**

The chimney connector assembly has been called 'the weak link' in the safety of wood heating systems because failure to install the connector properly (which has been common in the past) can result in house fires.

The best flue pipe assembly is one that rises straight up from the stove to the base of the chimney with no elbows. Straight assemblies are less likely to cause problems like smoke roll-out when the door is opened for loading. They are also more stable and easier to maintain than assemblies with elbows. Horizontal runs of flue pipe should be avoided where possible because they reduce chimney draft.

**The rules below are based on those found in the CSA B365 installation code. Please carefully follow these installation instruction rules, or those enforced where you live.**

**MAXIMUM OVERALL LENGTH OF STRAIGHT PIPE: 3 M (10 FT.) INCLUDING ELBOWS.**

**MINIMUM CLEARANCE FROM COMBUSTIBLE MATERIAL: 450 MM (18 IN.). THE MINIMUM CLEARANCE MAY BE REDUCED BY 50 PERCENT TO 225 MM (9 IN.) IF SUITABLE SHIELDING IS INSTALLED EITHER ON THE PIPE OR ON THE COMBUSTIBLE SURFACE.**

**THE ASSEMBLY SHOULD BE AS SHORT AND DIRECT AS POSSIBLE BETWEEN THE STOVE AND CHIMNEY. THE USE OF TWO 45 DEGREE ELBOWS IS OFTEN PREFERABLE TO A SINGLE 90 DEGREE ELBOW BECAUSE LESS TURBULENCE IS CREATED IN THE EXHAUST FLOW AND THEY RESULT IN LESS HORIZONTAL RUN.**

**MAXIMUM NUMBER OF 90-DEGREE ELBOWS: 2.**

**MAXIMUM UNSUPPORTED HORIZONTAL LENGTH: 1 M (3 FEET).**

**GALVANIZED FLUE PIPES MUST NOT BE USED BECAUSE THE COATINGS VAPORIZE AT HIGH TEMPERATURES AND RELEASE DANGEROUS GASES. USE BLACK PAINTED FLUE PIPES.**

**FLUE PIPES MUST BE AT LEAST 24 GAUGE IN THICKNESS.**

**FLUE PIPE JOINTS SHOULD OVERLAP 30 MM (1 1/4 IN.)**

**EACH JOINT IN THE ASSEMBLY MUST BE FASTENED WITH AT LEAST THREE SCREWS.**

**THE ASSEMBLY MUST HAVE ALLOWANCE FOR EXPANSION: ELBOWS IN ASSEMBLIES ALLOW FOR EXPANSION; STRAIGHT ASSEMBLIES SHOULD INCLUDE AN INSPECTION WRAP WITH ONE END UNFASTENED, OR A TELESCOPIC SECTION.**

**MINIMUM UPWARD SLOPE TOWARDS THE CHIMNEY: 20 MM/M (1/4 IN/FT.).**

**ONE END OF THE ASSEMBLY MUST BE SECURELY FASTENED TO THE FLUE COLLAR WITH 3 SHEET METAL SCREWS AND THE OTHER END SECURELY FASTENED TO THE CHIMNEY.**

**THERE MUST BE PROVISION FOR CLEANING OF THE PIPES, EITHER THROUGH A CLEAN OUT OR BY REMOVAL OF THE PIPE ASSEMBLY. REMOVAL OF THE ASSEMBLY SHOULD NOT REQUIRE THAT THE STOVE BE MOVED.**

**THE MALE ENDS OF THE SECTIONS MUST BE ORIENTED TOWARDS THE APPLIANCE SO THAT FALLING DUST AND CONDENSATION STAY INSIDE THE PIPE.**

**A FLUE PIPE MUST NEVER PASS THROUGH A COMBUSTIBLE FLOOR OR CEILING OR THROUGH AN ATTIC, ROOF SPACE, CLOSET OR CONCEALED SPACE.**

**WHERE PASSAGE THROUGH A WALL OR PARTITION OF COMBUSTIBLE CONSTRUCTION IS DESIRED, THE INSTALLATION SHALL CONFORM TO CAN/CSA-B365, INSTALLATION CODE FOR SOLID-FUEL-BURNING APPLIANCES AND EQUIPMENT.**

The ideal flue pipe assembly is one that rises straight up from the appliance flue collar and directly into the chimney with no elbows. A straight up connector assembly needs either a telescopic length or an inspection wrap (pipe coupler) to allow it to be assembled and disassembled without moving the stove.

A straight flue pipe assembly offers the least restriction to gas flow and results in stronger draft. Straight assemblies also need less maintenance because there are no corners to collect creosote.

The chimney connector must be in good condition.

## Appendix 1 : Installing an intake vent

### Installing an intake vent

- A hole must be drilled in the foundation to run the air intake pipe.
- The pipe must connect the heater to an outside air intake.
- It must be insulated and non-combustible.
- The pipe must be 4 in. in diameter and as straight as possible (without unnecessary bends).

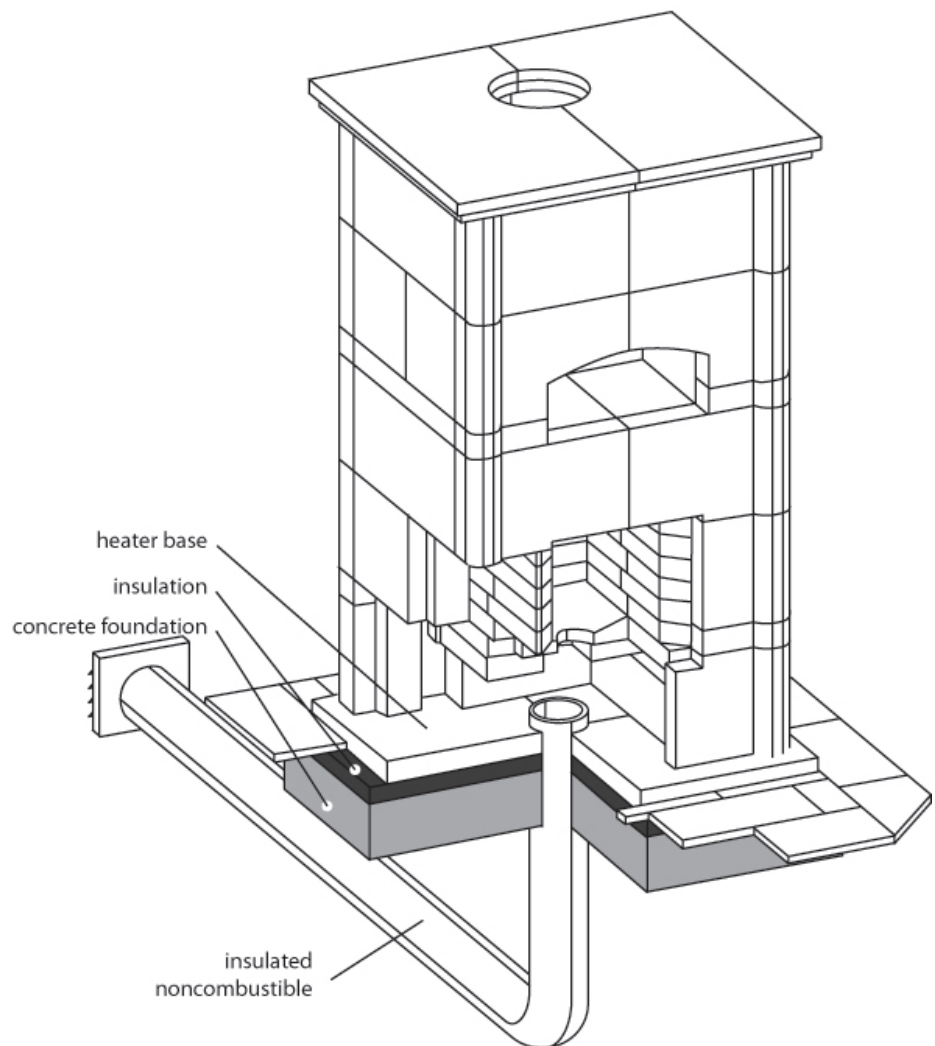

## **Appendix 2 : FM0400 Mass Fireplace Parts List**

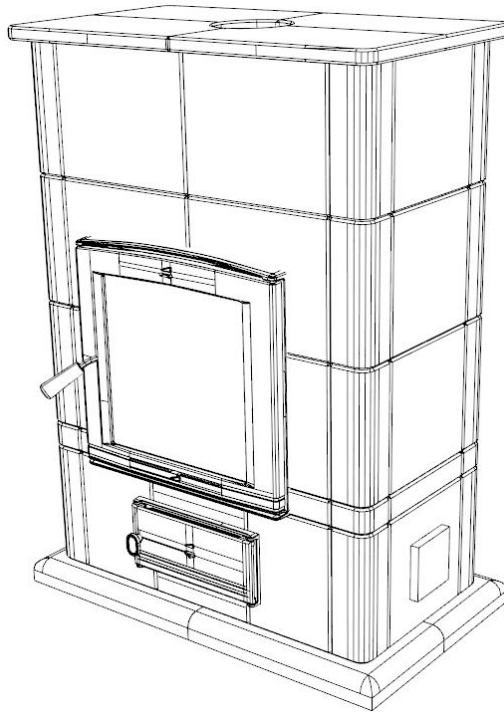

**See appendix FM0400**

## Appendix 2 : FM1000 Mass Fireplace Parts List

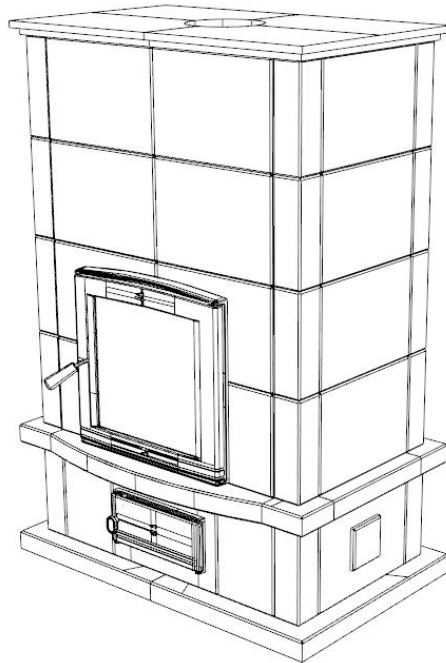

**See appendix FM1000**

## Appendix 2 : FM1000FO Mass Fireplace Parts List

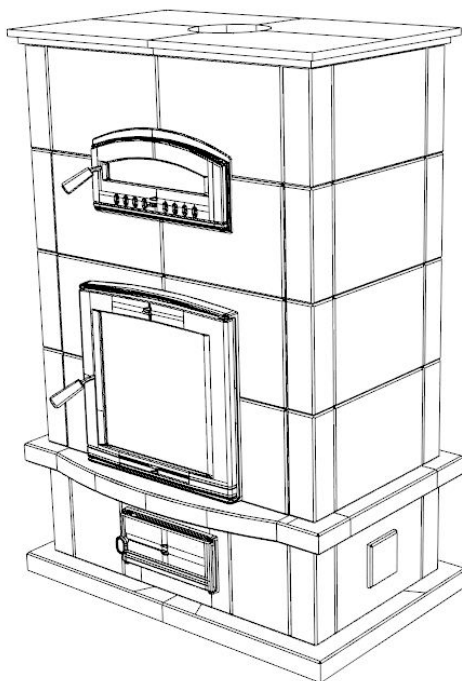

**See appendix FM1000FO**

## Appendix 2 : FM1200 Mass Fireplace Parts List

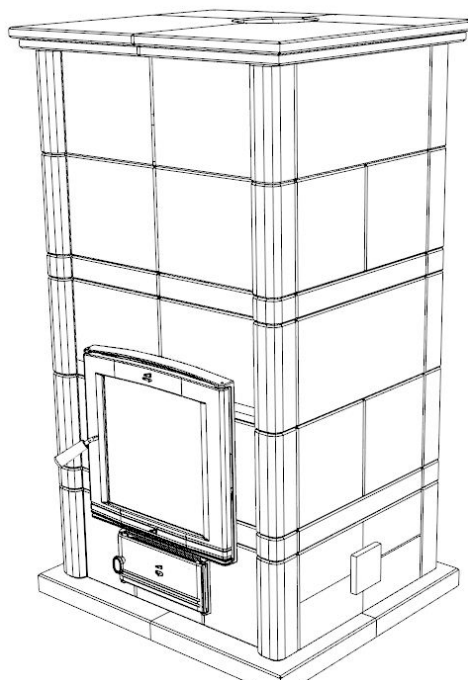

**See appendix FM1200**

## Appendix 2 : FM1200FO Mass Fireplace Parts List

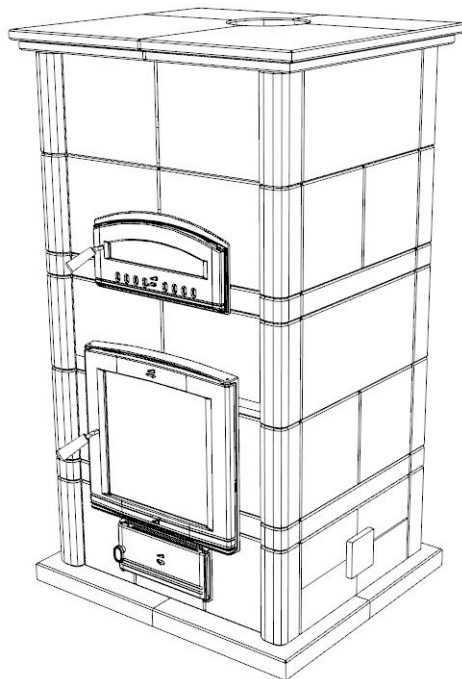

**See appendix FM1200FO**



## Appendix 2 : FM1200FOB Mass Fireplace Parts List

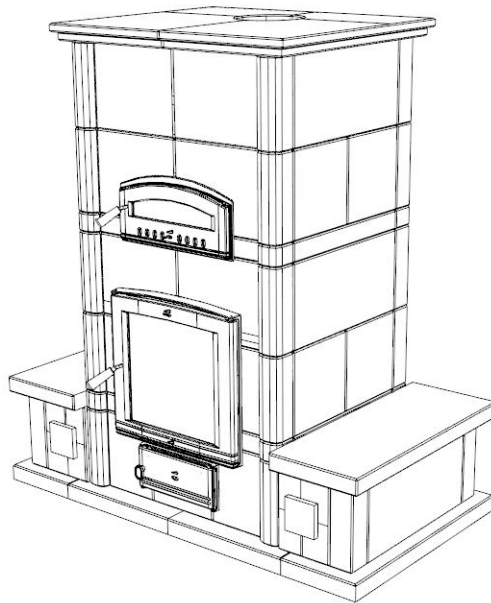

**See appendix FM1200FOB**

## Appendix 2 : FM1500FO Mass Fireplace Parts List

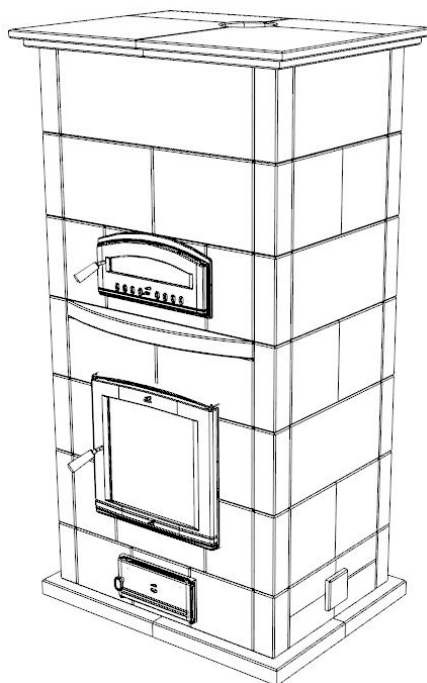

**See appendix FM1500FO**

## Appendix 2 : FM1500FOB Mass Fireplace Parts List

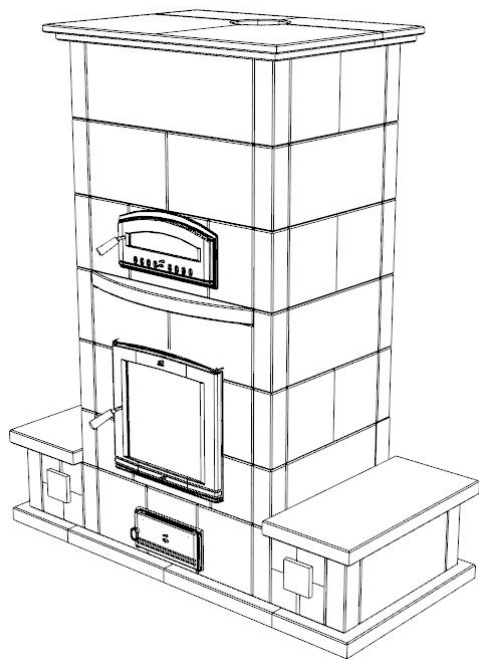

**See appendix FM1500FOB**

## Appendix 2 : FM1500FOB4 Mass Fireplace Parts List

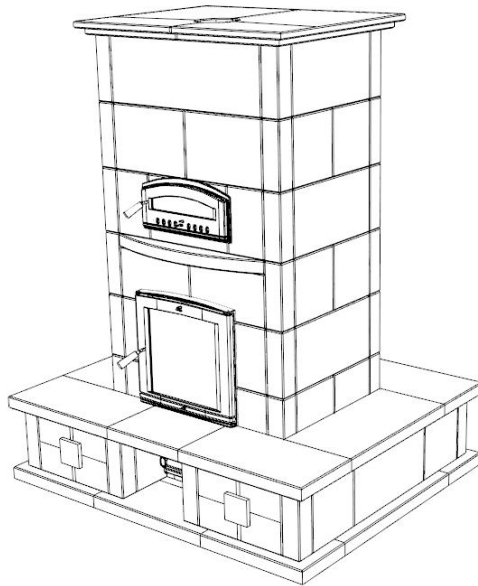

**See appendix FM1500FOB4**

## **Warranty**

Your appliance is covered by a 5-year conditional warranty.

This warranty is not transferable and applies to the original owner only.

The warranty comes into effect on the date of occupancy.

Use of the appliance before the date of occupancy, notably during construction of the residence, will invalidate the warranty.

This warranty only covers replacement parts for which material or workmanship defects are found, provided that the product was used in accordance with the instructions in this manual, and it will not extend to any accidental damages, consequential or indirect. This warranty does not cover damages caused by misuse or non-continuous use of the appliance, lack of maintenance, accident, abuse, negligence or alteration of the product.

This warranty does not cover the small cracks that may appear in the fire box, because these are normal and do not affect the operation of the appliance.